

# Raumplan Adalbert Stifter Gymnasium LINZ 2020/2021

## Vorderhaus

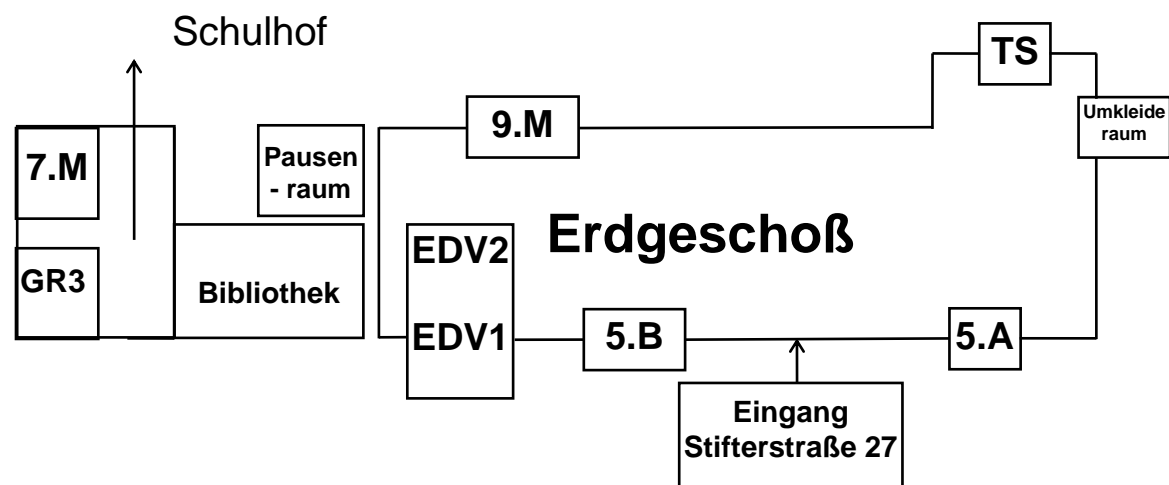

## Hoftrakt

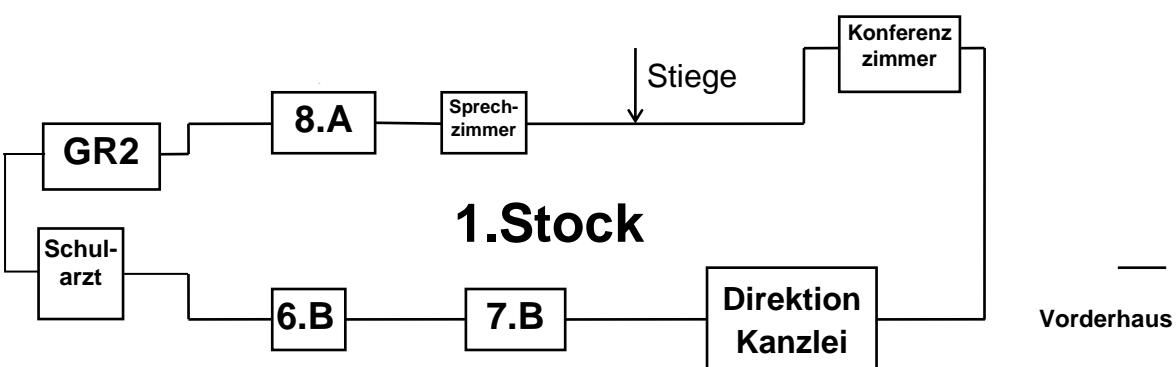
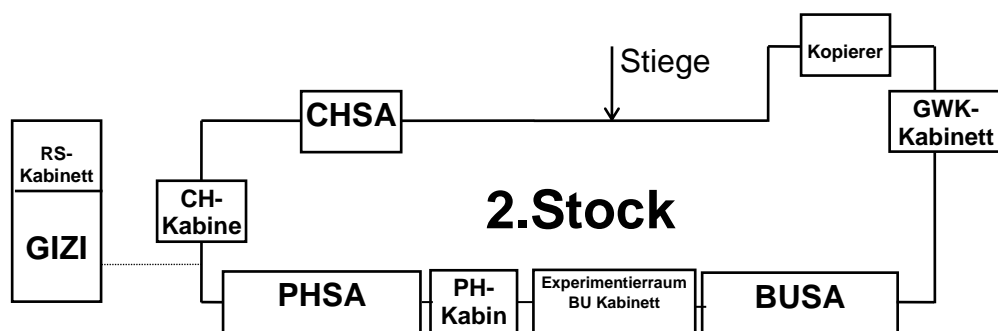
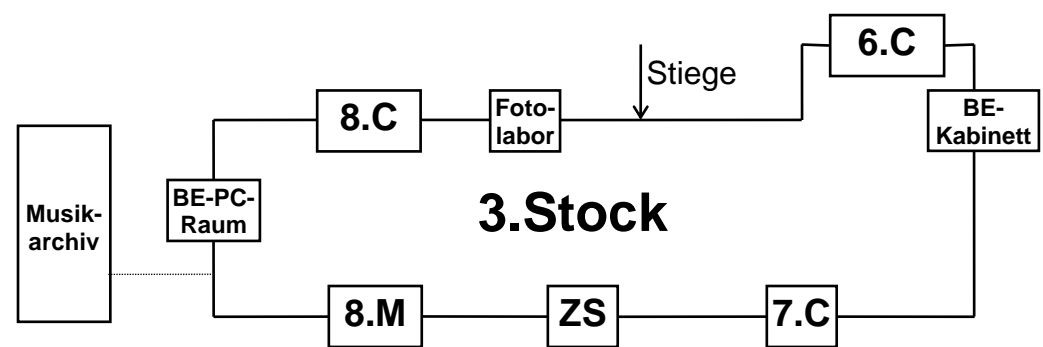
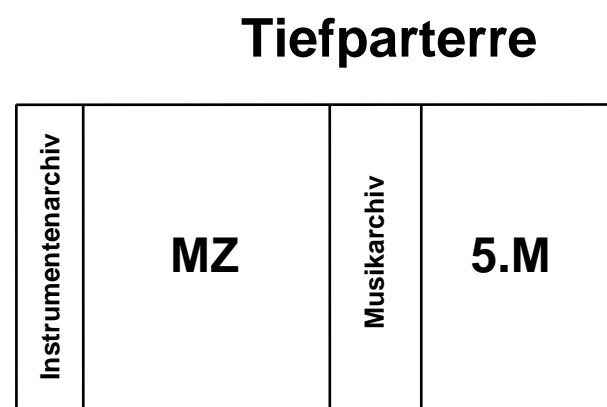
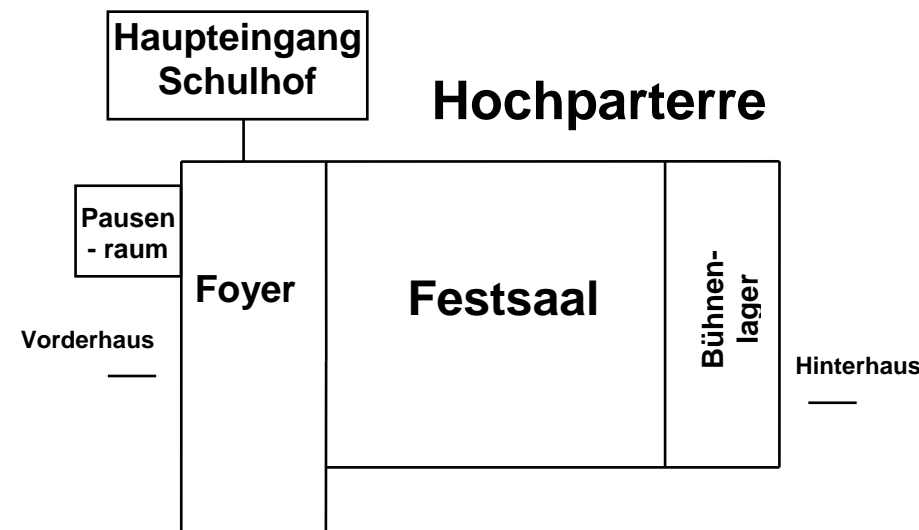

## Hinterhaus

